



# DRILL OPERATED JACKET & INSULATION REMOVAL TOOL

US16-7000



**WARNING! THIS TOOL SHOULD NOT BE USED ON LIVE ELECTRICAL CIRCUITS. IT IS NOT PROTECTED AGAINST ELECTRICAL SHOCK!**

Always use OSHA/ANSI/CE or other industry approved eye protection when using tools. This tool is not to be used for purposes other than intended. Read carefully and understand instructions before using this tool.

WARRANTY: RIPLEY warrants its products against defective materials and workmanship for a period of two years from date of shipment from the RIPLEY factory provided the product is utilized in accordance with instructions and specified ratings.

## Product Overview

The **UtilityTool® US16 Drill Operated Jacket Removal Tool** is used to remove outer jackets on medium voltage power cable with the assistance of drill power. The drive body is powered by a battery powered variable speed drill. The cable is guided through the tool by means of a reducing bushing sized to the cable's overall diameter. The US16 is both an efficient and ergonomic method for jacket removal. It is especially useful for removing long lengths of JCN cable jacket, as often needed with terminator installation. The US16 is also used to remove longer lengths of insulation from insulated overhead cables for cable pulling and dead ending.

## Product Features

- URD jacket is cleanly removed to expose cable shielding
- Overhead cable insulation removal to expose bare conductor
- Micro indexing blade depth control to protect cable shielding
- Self feeding design with greatly reduced operator fatigue
- One tool adjustment: blade depth adjustment for the cable being stripped
- Cable capacity: up to 1.5" cable diameter
- Size: 13" x 10.5" x 4.25"
- Weight: 4.55 lbs

## Operating Instructions - URD Jacket Removal

### 1. Bushing sizing and selection

The US16 tool relies on an appropriate bushing fit and clearance to a cable's actual outer diameter. We recommend to submit a 3 to 4 foot sample of your cable to the Ripley Tools engineering department for review and sizing. Ripley will best-size a bushing diameter that will allow for typical over/under cable variation. Generally, the cable allowance will normally be about 1/32".

Each bushing will be identified by conductor size and cable type for convenience in the field. In addition the bushing part number will stamped on the bottom side for ease of re-ordering.

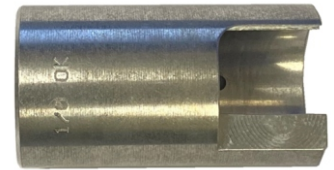

US16 bushing



CABLE OD

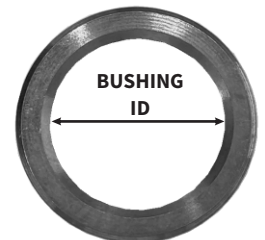

BUSHING ID

## 2. Attach the drill

Only use a variable speed, non-impact style drill. Lock the drill chuck onto the 3/8" drive stud in the US16 tool. Note that the lower bracket has up and down adjustment to obtain a proper fit with the drill and also provide maximum hand space to operate the tool. Loosen the (4) bracket adjustment screws, position the bracket until it meets and touches the top of the drill pack, then secure them tight.

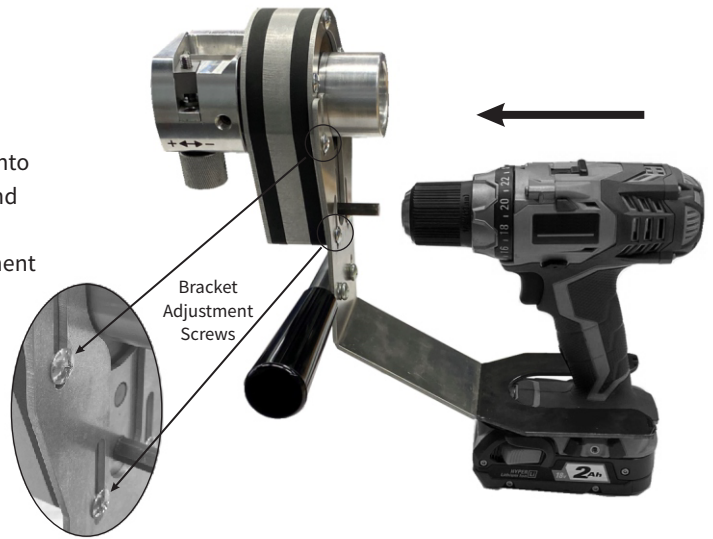

## Safety note

Most variable speed drills are built with a lock out setting for the trigger switch. Use this drill feature when making blade adjustments or bushing change outs to help ensure personal safety.

## 3. Blade Adjustment

The US16 blade adjustment is the large knurled knob on the rotating head at the front of the tool. A right hand rotation, toward the - mark, will raise the blade. Left hand rotation toward the + mark will drop the blade deeper.

Adjust the blade upward out of the working zone. Raise the blade until the end of adjustment screw is flush with the top of the blade, as shown here.



## 4. Attach the bushing

Insert the bushing into the tool. Secure it with the spring plunger.

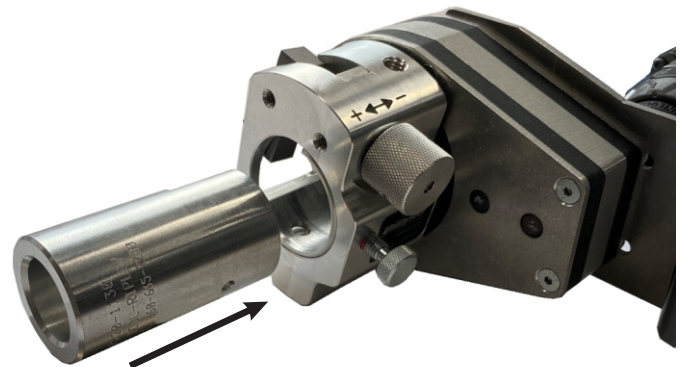

## 5. Cable preparation

The cable condition is important when stripping with the US16 tool. Train the cable as straight as possible and ensure the cable end is cut off clean and square with a band saw, hack saw, or good pair of cable cutters that keeps a round form on the cable.

## 6. Set the blade depth

If available, use a scrap piece of the cable to set the blade. A start depth can be established by following these steps.

- A. The blade should be out of the working zone from step 4 above.
- B. Insert the cable into the bushing and slide it past the blade a couple of inches.
- C. Drop the blade until it touches the cable. Then index it 2 or 3 more clicks deeper so there is some pressure on the jacket.
- D. Remove the cable. Drag should be felt from the blade.

The blade is typically set to around .020" above the cable shielding. This will allow the tool to make a clean strip of the jacket and also protect the shielding from damage.

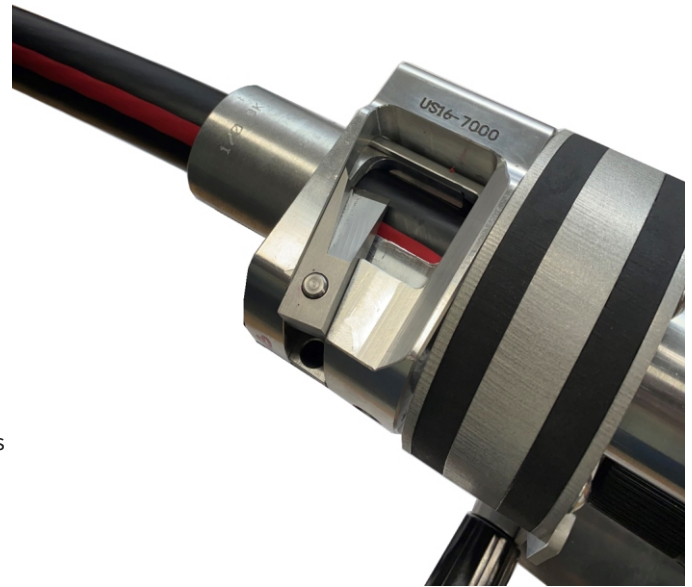

## 7. Operation

Re-insert the cable up to the blade. Run the tool slowly with light forward pressure to start the stripping operation. Carefully observe the strip performance. Re-set the blade to get the most reliable strip result. For long strips, stop the tool and trim the insulation chip. The tool can be manually backed off or run up against a stop clamp to end the stripping operation. For an accurate strip length, note that the bushing extends exactly 2" past the blade cut. Add this 2" to the desired strip back length to locate the clamp. Avoid freewheeling with the tool. When the insulation chip breaks off, immediately stop the drill. Then extract the tool off the cable.



## Operating Instructions - Overhead Insulation Removal

In general, insulation removal is accomplished by the same procedure as jacket removal. Refer to the URD jacket removal steps 1-5.

**1. Bushing selection.** The US16 tool relies on an appropriate bushing fit and clearance to a cable's actual outer diameter. This cable allowance will normally be about 1/32" and bushing sizing can be referenced in the chart below.

**2. Blade depth setting.** Attach the bushing to the tool. Insert the cable up to the cutting blade. Adjust the cutting blade to 1/32 - 1/16" above the highest point of the conductor (Fig. A). On the initial blade setting, set the blade toward a conservative shallow depth to avoid injury, tool damage and cable damage. Make a short strip. Then, re-adjust appropriately if needed. A stripped cable remnant can be inserted into the tool to serve as a gage to assist in setting the depth (Fig. B).

**3. Operation.** Run the tool at a slow speed (75-150 RPM). As the insulation chip becomes too long, stop the tool and trim the chip. To end the strip process, manually back off the tool or use a stop clamp as mentioned on page 3.

Cable	Bushing
1/0 17kv 6/1 ACSR 165 mil	US16-7100-0775
336.4 MCM 17kv 18/1 ACSR 165 mil	US16-7100-1050
336.4 MCM 17kv 30/7 ACSR 165 mil	US16-7100-1125
653.9 MCM 17kv 18/3 ACSR 180 mil	US16-7100-1350
1/0 35kv 6/1 ACSR 165 mil	US16-7100-1075
336.4 MCM 35kv 18/1 ACSR 165 mil	US16-7100-1350
336.4 MCM 35kv 30/7 ACSR 165 mil	US15-7100-1425

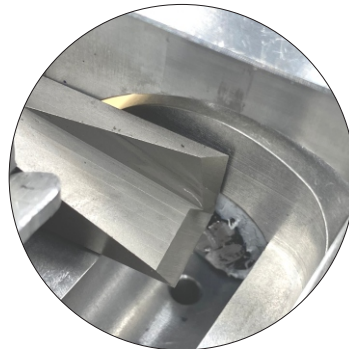
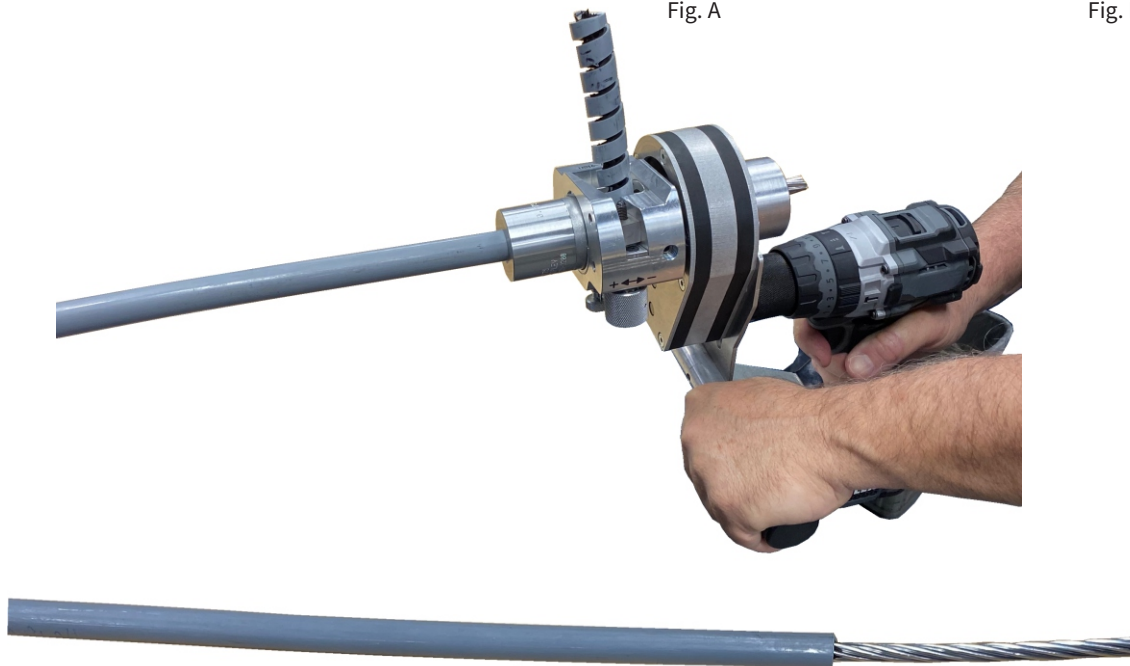

Fig. A



Fig. B



### 8. Blade Replacement

Rotate the blade adjustment knob in the “ ” direction to continuously raise the blade until it unthreads off the adjustment screw. Carefully thread the new blade onto the screw.

#### Ordering Information

Description	P/N
US 16 tool	US16-7000
US 16 replacement blade	US16-7500

## Ripley Tools LLC

46 Nooks Hill Road, Cromwell, CT 06416  
 Phone: +1 (800) 528-8665 · Fax: +1 (860)635-3631 · Email: [csr@ripley-tools.com](mailto:csr@ripley-tools.com) · [www.ripley-tools.com](http://www.ripley-tools.com)

# US16